

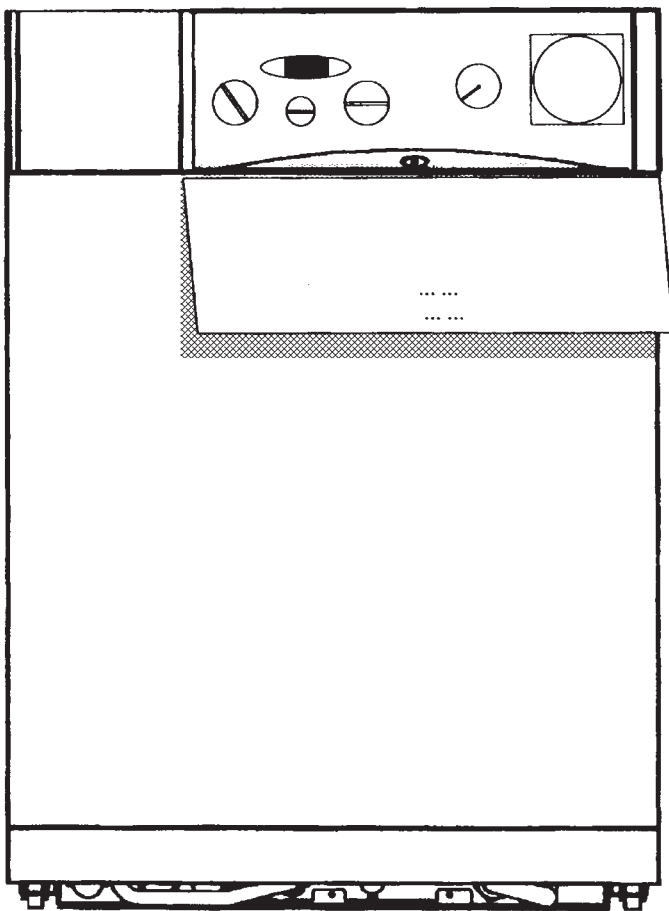

*Linea* max

Room Sealed, Fanned Flue, Combination Boiler



# User Instruction



BRITISH GAS SERVICE LISTED  
G.C. No 47 094 30

THESE INSTRUCTIONS  
TO BE RETAINED  
BY USER



The code of practice for the installation,  
commissioning & servicing of central heating systems

**BEFORE ATTEMPTING TO LIGHT APPLIANCE PLEASE MAKE SURE THAT IT IS CHARGED UP WITH WATER WITH THE NEEDLE POINTING AT 1bar ON THE PRESSURE GAUGE ( 2 Fig.1 )**

### Gas Safety (Installation and Use) Regulations 1998

In your own interests and that of safety, it is the law that all gas appliances are installed and serviced by a competent person in accordance with the regulation.

### GAS LEAK OR FAULT

IF A FAULT OR GAS LEAK IS SUSPECTED, TURN OFF THE APPLIANCE AND CONTACT YOUR INSTALLATION COMPANY, GAS SUPPLIER OR NEAREST VOKÈRA OFFICE.

### LOGBOOK

A log book is supplied with the boiler. This important document must be completed by your installer during the Installation / commissioning of your boiler. Failure to install and commission the appliance to the manufacturers instructions may invalidate the warranty. This does not affect your statutory rights.

Please keep your logbook handy, as you will be asked to quote certain information from the log book should you need to contact Vokèra Ltd in the unlikely event of a problem occurring with your boiler.

## INTRODUCTION

Your Vokèra Linea Max is a central heating boiler supplying central heating and instantaneous domestic hot water only. In the winter when both Central Heating and Hot Water are needed the central heating circulation stops when hot water is being drawn off. This normally will not affect the level of heating.

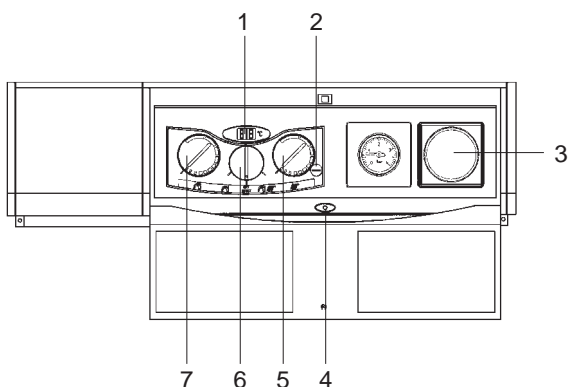

Fig. 1

### Boiler Location

#### Clearances

Minimum - above casing 20mm (3/4in)

Minimum - In front 600mm (24in)

Minimum - At sides 12mm (1/2in from casing)

Any purpose provided ventilation openings must not be blocked, and should be checked periodically to ensure this. If the appliance is fitted in a compartment it should not be used as a storage cupboard (e.g. for food).

### NEVER HANG CLOTHES ETC. OVER THE APPLIANCE.

1. Temperature/Fault Indicator.
2. Pressure Gauge.
3. Timeclock Aperture (optional).
4. Status LED green = normal, red = fault
5. Central Heating Temperature Control knob.
6. Mode Selector Switch.
7. Hot Water Temperature Control Knob.

## ELECTRICITY SUPPLY

### WARNING:

#### THIS APPLIANCE MUST BE EARTHED

Connection should be made to a 230v 50Hz supply. The appliance must be protected by a 3amp fuse if a 13amp (BS 1363) plug or fused spur is used.

To connect a plug:

As the colour of the wires in the mains lead to this appliance may not correspond with the coloured markings identifying the terminals in your plug, proceed as follows:-

The wire which is coloured green-and-yellow must be connected to the terminal in the plug which is marked with the letter E or by the earth symbol W or coloured green or green-and-yellow.

The wire which is coloured blue must be connected to the terminal which is marked with the letter N or coloured black

The wire which is coloured brown must be connected to the terminal which is marked with the letter L or coloured red.

## 1.0 Operation

1.1 **OFF** Appliance will not activate if tap is turned on or heating timers/controls are operated. Frost protection is still active (see 1.3).

1.2 When the mode selector switch is selected (other than OFF), with no demand for heating or hot water the appliance will periodically light to preheat the domestic hot water thermal store. This is done to ensure that when a demand is made for domestic hot water the appliance is not cold, thereby reducing the wait for hot water, and maximising hot water production.

If the appliance is unused for 19 hours the motorised valve will operate one cycle, and the pump will run for a period of 1 minute automatically (provided the electrical supply to the appliance is on). This will help prevent these components becoming stuck if the appliance is not used for long periods.

## 1.3 Frost Protection

The appliance will automatically ignite in central heating mode if the appliance temperature drops to approximately 5°C. The appliance will continue to operate in central heating mode until it reaches approximately 40°C.

## 2.0 Hot Water Only

Ensure electricity supply is on. (Status LED indicating green).

2.1 With the boiler mode selector switch (6) turned to (Fig. 2) the main burner will ignite electronically whenever water is drawn from the tap.

2.2 Should the boiler fail to ignite the status LED will flash red (this will be accompanied by an error code showing at the the fault indicator (1) see 4.0 for list of error codes and remedies. Turn the mode selector switch (6) to the reset position for a period of at least 10 seconds then turn back to the original position before drawing water again. The appliance will re-attempt ignition. Should lockout continue the appliance must be checked by a competent person.

2.3 The maximum water flow rate to the tap is set at a predetermined maximum delivery. The temperature of water at the tap can be varied by adjusting the water flow rate at the tap up to the predetermined maximum. The hot water temperature control knob (7) will govern the maximum temperature. Turning the knob clockwise increases the setting, anticlockwise decreases setting. (Fig. 3) When the appliance is being used in the hot water mode the temperature/fault indicator (1) indicates the approximate temperature of the hot water leaving the appliance.

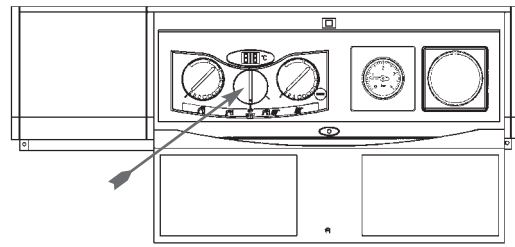

Fig. 2

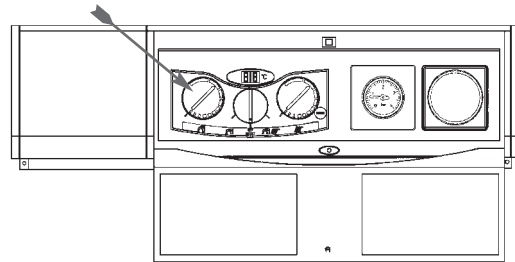

Fig. 3

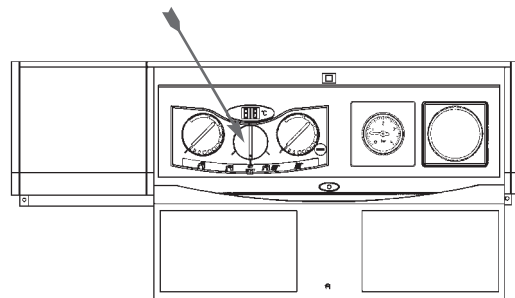

Fig. 4

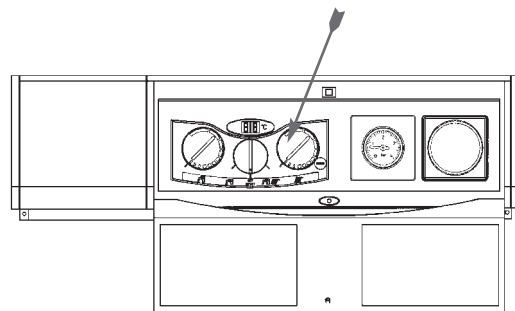

Fig. 5

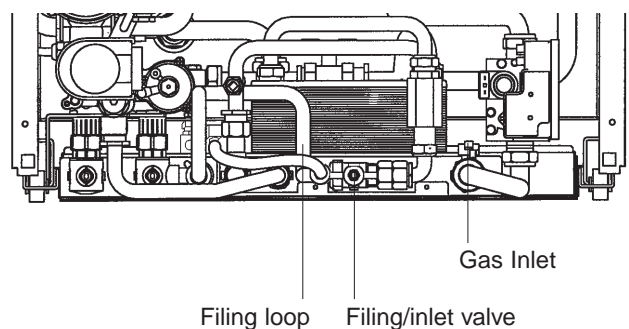



Fig. 6

**3.0 Heating and Hot Water**  
Ensure Electricity is on (Status LED showing green).

**3.1** With the boiler mode selector switch turned to  (fig. 4), ensure either internal timer or external controls such as time clock and/or room thermostat are calling for heat. The boiler will now go through an ignition sequence and the burner will light.

**3.2** Should the boiler fail to ignite and the status LED (4) flash red, (this will be accompanied by an error code showing at the the fault indicator (1). See **4.0** for list of error codes and remedies. Turn the mode selector switch (6) to the reset position for a period of at least 10 seconds then turn back to the original position. The appliance will re-attempt ignition. Should the lockout continue the appliance must be checked by a competent person.

**3.3** Adjust the central heating temperature control knob (5) to suit the weather, turning clockwise to increase setting, anticlockwise to decrease setting (Fig.5). When the appliance is being used in the central heating mode the temperature indicator (1) indicates the approximate temperature of the central heating water leaving the appliance.

**N.B** (i) For the quickest heat up of the premises the highest setting is needed at first, turning down later.  
(ii) When a room thermostat is used, it may be best to leave the boiler thermostat at a high setting and set the room thermostat as required.

**4.0 Error Codes**  
Should the appliance indicate a lockout (status LED flashing red), this will be accompanied by an error code shown in the temperature/fault indicator (2). Error codes could be between **01 - 08**:

- 01** Lockout (failure to ignite). Turn mode selector switch to reset position for approximately 10 seconds then back to the original position.
- 02** Overheat. Wait for appliance to cool sufficiently (approximately 15 minutes), then reset as for code 01.
- 03** Problem with fan/flue. Reset as for code 01.
- 04** Insufficient water pressure (see **5.1**) or poor flow in system. Check pressure gauge reading (2). If lower than 0.5bar repressurisation is necessary. See **5.2** 'restoring pressure'. When pressure is restored reset as for code 01

**05 to 08** Reset as for code 01

**Should the appliance continue to lockout, call your installer or service engineer.**

**5.0 Safety Limits**

**5.1 System pressure**

Ideally the water pressure gauge (2) should read between 1bar and 1.5 bar when the system is cold. Leaks or radiator venting will reduce this. **DO NOT UNDER ANY CIRCUMSTANCES USE THE APPLIANCE WITH THE PRESSURE GAUGE READING ZERO.** Call in your installer or service engineer if excessive topping up of the system to restore pressure is necessary.

A built-in safety valve operates if boiler pressure exceeds 3bar whether hot or cold. If the safety valve operates (water/steam discharges to drain) switch off and call your installer or service engineer.

**5.2 Restoring Pressure**

If the pressure reading on the pressure gauge (2) falls to below its normal operating pressure (see clause 5.1) the system/boiler will need repressurising as follows:

Gain access to the interior, push to release the control panel door, locate the small tool inside and undo the 2 screws securing the front panel to the appliance and remove.

**a)** Identify the filling/inlet valve (found at the base of the appliance) and C/H Filling Cock. See fig. 6 & 7.

**b)** The 'filling loop' may have been disconnected from the filling/inlet valve; if so reconnect (fig. 6) unscrewing the cap as necessary.

**c)** The filling/inlet valve has 3 positions:

**(i)** Vertically up - Closed position.

**(ii)** Turn to the left to horizontal - Filling position.

**(iii)** Turn to the right to horizontal - Normal operating position. See fig. 7.

To fill, open the C/H Filling Cock and slowly turn the handle of the filling/inlet valve past the closed position towards the filling position. Mains water will be heard to enter the system/boiler. As the water enters the system/ boiler the pressure gauge will be seen to rise. Pressurise to between 1bar & 1.5bar when the system is cold.

**DO NOT OVERPRESSURISE.**

Once the desired pressure is achieved turn the filling/inlet valve back past the closed position and into the normal boiler operating position. Then close the C/H Filling Cock.

**d)** Disconnect the 'filling loop' (and keep in a convenient and safe place for filling in the future. Replace cap on valve.

**Note:**

Occasional repressurisation is a normal part of care and maintenance carried out by the end user. However excessive repressurising can be detrimental to the eventual life span of the appliance and should be addressed by an installer/service engineer.

**5.3**

If the appliance water temperature rises too high, a high limit thermostat operates to extinguish the burner. This automatically resets when the appliance cools sufficiently.

## 6.0 Shutting Down the System

For short periods:

Turn mode selector switch to 'OFF'

As described in 1.3 the appliance has an in built frost thermostat, it is therefore possible that the appliance will operate in the OFF mode should the temperature at the appliance fall sufficiently.

However, if the building is vacated or extremities of the heating system could be subject to risk of freezing shut down and drain the system as follows:

Turn off the gas cock (fig.8)

Turn off the electricity supply to the appliance.

Open all heating radiator valves and drain through the cocks usually provided at the lowest point of the system. To ensure draining of radiators, open radiator air vents remembering to close them when the operation is complete.

Alternatively install a frost thermostat/s to protect the extremities of the central heating system and leave the mains electricity and gas turned on.

## 7.0 Relighting the Appliance

Relight by following steps 2.0 or 3.0 above, after ensuring that the refilling of the system has been carried out and the pressure is correct.

## 8.0 Cleaning the Outer Case

Use a clean damp cloth. Do not use abrasive cleaners.

## 9.0 Spare Parts and Servicing

Your Vokèra Linea must be serviced annually. Please contact your local Vokèra service department, your local gas region or competent installer.

Filing/inlet valve

### Normal Operating Position

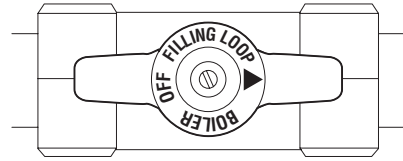

### Closed Position

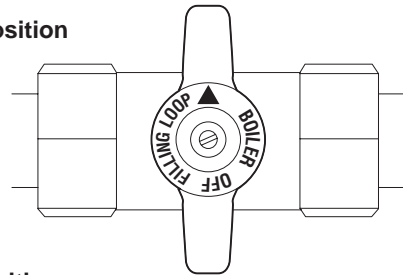

### Filling Position

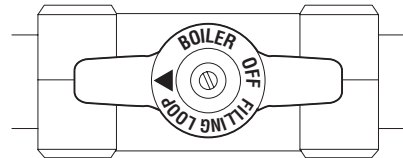

### C/H Filling Cock

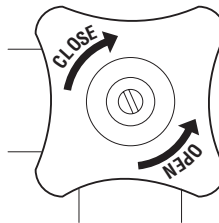

Fig. 7

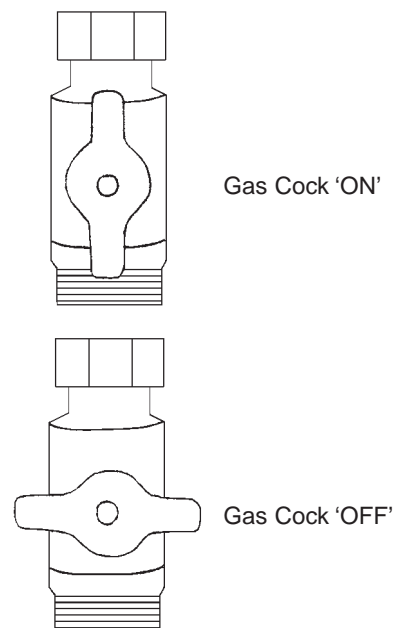

Fig. 8

# VOKÈRA TIME CLOCKS

## MECHANICAL 24 HR VERSION

See Fig. 9

Setting the time.

The time of day can be set by grasping the outer edge of the black dial and turning it in a clockwise direction until the correct time is in line with the white pointer.

Setting the 'switching times'

The 'ON' periods are set by sliding the black tappets, adjacent to the time periods required, to the outer edge of the dial.

The tappets that remain at the centre of the dial will be the 'OFF' periods.

**N.B.** The smallest switching time (ON or OFF) is 15 minutes.

To select '**Timed**' mode move the selector switch in the middle of the clock face to the  position.

To select '**Constant**' mode move the selector switch in the middle of the clock face to the '**I**' position.

To select '**Off**' mode move the selector switch in the middle of the clock face to the '**O**' position.

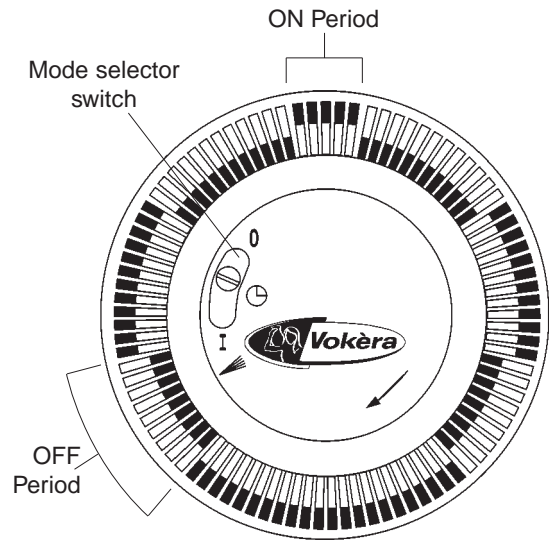

Fig. 9

## DIGITAL 7 DAY VERSION

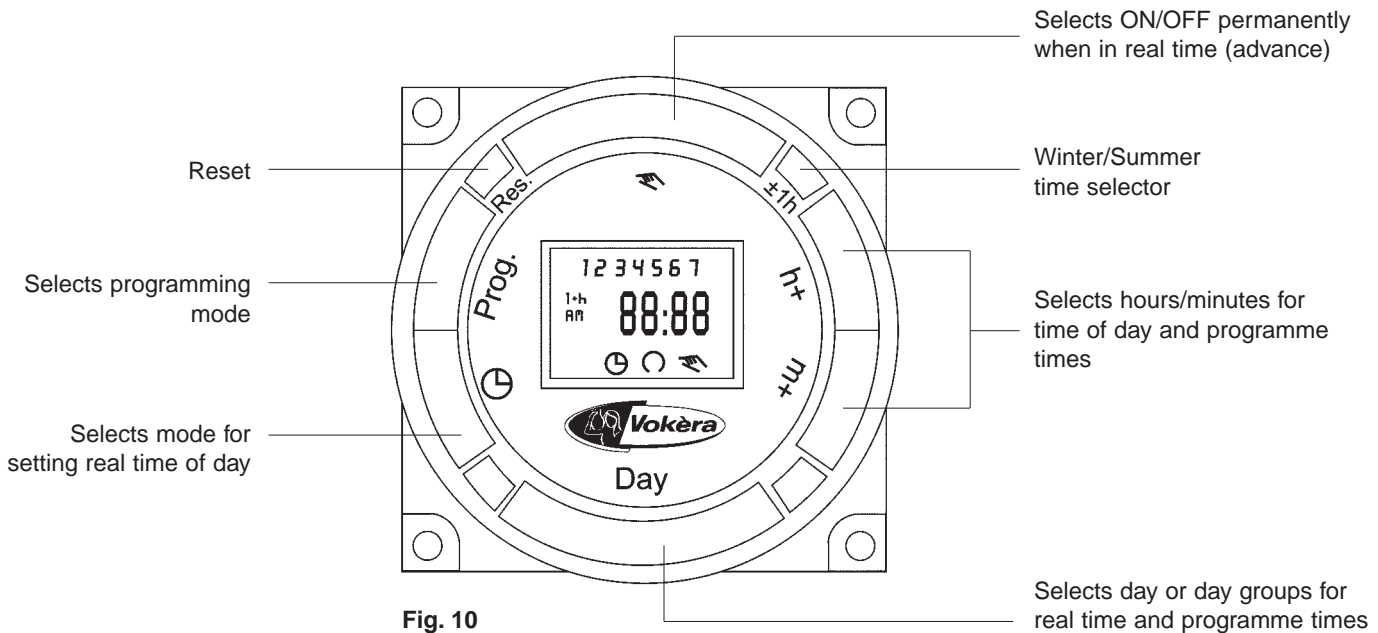









Fig. 10

## SETTING INSTRUCTIONS

The Vokèra digital timeswitch has, besides the normal group timing facility, capacity to programme individual daily settings. It has a total of 20 storage spaces for switching operations. Each space can be programmed as either an ON or OFF instruction, and can be applied to any one day or four day combinations.

## SCREEN INFORMATION



Days of week	1 2 3 4 5 6 7
ON selection	
OFF selection	
Continuously ON	
Continuously OFF	
Winter/Summer time +1hr	
Timed mode	
Override selection	
Programme spaces	-- : --
Number of free spaces	FR







## **BEFORE PROGRAMMING**

Press the reset button using a pencil or similar instrument. This clears the memory of unwanted information in readiness for programming. The reset button should be used in the event of local interference causing the timeswitch to appear to malfunction. Local interference dependent on location may be present from time to time.



## **SET CURRENT TIME AND DAY**

- 1 Press and hold the  button during operations 2 - 5 below.
- 2 Press the 'Day' button to select the current weekday ( 1 = Monday, 2 = Tuesday etc.)
- 3 If setting in British summertime press the +/- 1h button once.
- 4 Press the 'h+' button to select the correct hour.
- 5 Press the 'm+' button to select the correct minute.
- 6 Now release the  button - the colon between the hours and minutes will flash to indicate that the clock is running.









## **ENTERING SWITCHING TIMES**

- 1 Press the 'prog.' button to select the first free memory location.
- 2 Press the 'Day' button to select the day or group of days required for switching to occur. You have a choice of day groups: 1 - 7 (Mon - Sun), 1 - 6 (Mon - Sat), 1 - 5 (Mon - Fri), 6 - 7 (Sat & Sun), or any individual day. Each programme space automatically starts with the day selection 1 - 7. You can change this with the day button.
- 3 Press the 'h+' button to select the hour the switching is to occur.
- 4 Press the 'm+' button to select the minute the switching is to occur.
- 5 Press the  button once to select an ON  instruction, or twice to select an OFF  instruction.
- 6 Press the 'Prog.' button to store your programmed information, and select the next free programme space. Or if you have finished loading the programme press the  button which will save the programme and return the timeswitch to the current time display.
- 7 Programme further switching instructions as above.
- 8 Pressing the 'Prog.' button one additional time after you have finished programming displays the remaining number of programme spaces that are free, e.g. 'Fr 12'. If all programme spaces are full, 'Fr 00' will appear.

**Important Note:** After programming is completed, and you return the timeswitch to the current

time display with the  button, the timeswitch will not activate any switching instruction required for the current time. You may need to manually select the desired switching state with the  button. Thereafter, as the unit encounters further switching instructions in the memory in real time, it will correctly activate all subsequent switching instructions.

## **MANUAL OVERRIDE**

With the  button you can manually operate the switch to switch ON or OFF outside the programmed times, or you can put the switch into a permanent ON or OFF condition. The first press of the  button advances the output to ON or OFF ( or ) together with the  symbol displayed to show that the programme has been overridden) without disrupting the programme sequence. The second press fixes the output in the continuously ON  condition. The third press fixes the output in the continuously OFF  condition. In either fixed condition, the timeswitch will only revert to the timed condition if you press the  button once more.

## **READ OR CHANGE PROGRAMMED INFORMATION**

Press the 'Prog.' button repeatedly to view each of your programmed instructions in the order in which they were programmed. You can stop to alter any of the instructions using the buttons as described in 'entering switching times' above.

## **RUNNING RESERVE**

In the case of mains electrical failure, the internal battery will ensure that the actual time of day continues to operate and that the automatic switching programme remains intact. The clock can be programmed completely even without mains supply, provided the battery back up is fully charged. (Charging time 70 hours approx.)

## **SUMMER / WINTER CHANGEOVER**

From summer time to winter time: Depress the **+/-1h** key once (symbol **+/-1h** disappears from display).  
From winter to summer time: Depress the **+/-1h** once. Display shows **+/-1h** symbol).  
Alternatively you can follow the instructions described in 'set current time and day' above.



**PUTTING THE ACCENT ON QUALITY**

**Vokèra Ltd.**

**Web: [www.vokera.co.uk](http://www.vokera.co.uk)**

**Southern Region:** Morson Road, Enfield, Middlesex EN3 4NQ. Sales: 020 8216 6300. Fax: 020 8805 6320.

Parts: 020 8216 6310. Technical Helpline: 01274 866110. Customer Services: 0870 333 0220.

E-mail: [enfields.spares@vokera.co.uk](mailto:enfields.spares@vokera.co.uk)

**Northern Region:** Stubs Beck Lane, West 26 Business Park, Whitehall Road, Cleckheaton, West Yorkshire BD19 4TT. Sales: 01274 866100.

Fax: 01274 865557. Parts: 01274 866140. Technical Helpline: 01274 866110. Customer Services: 0870 3330220.

E-mail: [bradford.spares@vokera.co.uk](mailto:bradford.spares@vokera.co.uk)

**Scottish Region:** Shuna Street, Maryhill, Glasgow G20 9NW. Sales: 0141 945 6800. Fax: 0141 945 5136.

Parts: 0141 945 6820. Technical Helpline: 0141 945 6810. Customer Services: 0870 333 0220.

E-mail: [glasgow.spares@vokera.co.uk](mailto:glasgow.spares@vokera.co.uk)

**Vokèra (Ireland) Ltd:** West Court, Callan, Co. Kilkenny, Ireland. Sales/Parts: 056 55055.

Fax: 056 55060. Technical Helpline/ Customer Services: 056 55057.

E-mail: [eire.spares@vokera.co.uk](mailto:eire.spares@vokera.co.uk)